

# PROFESSIONAL OUTDOOR KITCHEN









**FULGOR MILANO**

GAS BARBECUE

**FOBQ 1000 G X**



-  Gas supply
-  Gas safety
-  AISI 316 stainless steel
-  Teppan yaki cooking
-  Gas Barbecue
-  Stainless steel racks

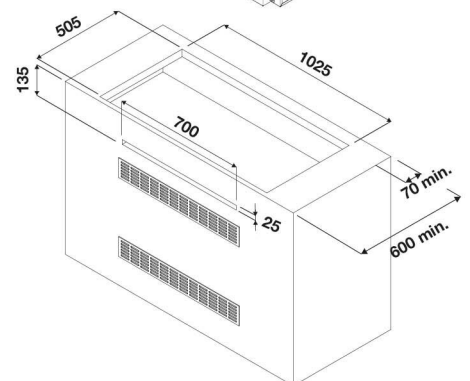
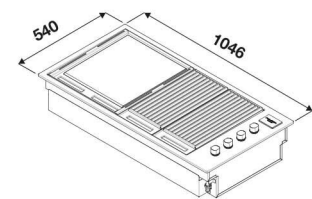
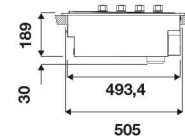
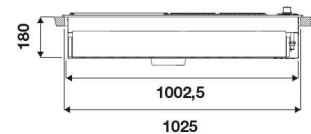

## OUTDOOR GAS BARBECUE

AISI 316 stainless steel

### FEATURES

- 4 tubular in-line gas burners
- Natural Gas supply (LPG convertible)
- Total gas power output: 14 kW
- 2 stainless steel grill racks (two units each)
- Stainless steel plate (teppan yaki)
- Side-mounted metal knobs

### MODES

- Barbecue broiling
- Baking (with lid)
- Keep warm

## SAFETY

- GasProtekt
- Gas detection and gas stop systems