

Cube Cube 50 | 134.0055.292

PRODUKTFAMILIE : **Abfalltrennsysteme** | PRODUKTSERIE : **Cube** | MODELL : **Cube 50** | MATERIAL/ OBERFLAECHE :
Andere | EINBAUART/ VARIANTE : **Deckenhaube**

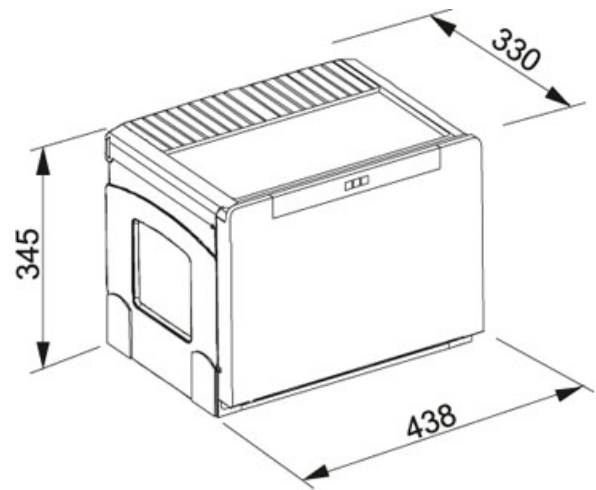

TECHNISCHE DATEN

Unterschrank	500,00 mm
Länge	438,00 mm
Breite	330,00 mm
Tiefe	345,00 mm
Behälter	1 x 18l + 1 x 14l
Schliessmechanismus	Automatikauszug

Cube Cube 50 | 134.0055.292

PRODUKTFAMILIE : **Abfalltrennsysteme** | PRODUKTSERIE : **Cube** | MODELL : **Cube 50** | MATERIAL/ OBERFLAECHE :
Andere | EINBAUART/ VARIANTE : **Deckenhaube**

PASSENDE PRODUKTE



134.0055.293



134.0055.289



134.0055.291
